

**LDG Z-11ProII  
100-Watt Automatic  
Tuner**



**LDG Electronics**

1445 Parran Road  
St. Leonard MD 20685-2903 USA

Phone: 410-586-2177

Fax: 410-586-8475

[ldg@ldgelectronics.com](mailto:ldg@ldgelectronics.com)

[www.ldgelectronics.com](http://www.ldgelectronics.com)

---

---

# Table Of Contents

Introduction	3
Jumpstart, or “Real hams don’t read manuals!”	3
Specifications	3
An Important Word About Power Levels	4
Important Safety Warning	4
Getting to know your Z-11Proll	5
<i>Front Panel</i>	5
<i>Rear Panel</i>	6
Installation	7
Optional Internal Battery Installation	9
Operation	10
<i>Basic Operation</i>	10
<i>Basic Tuning</i>	11
<i>Toggle Bypass Mode</i>	12
<i>Toggle Automatic / Semiautomatic Tuning Mode</i>	13
<i>Automatic Tuning Mode</i>	13
<i>Manual Memory Tuning</i>	13
<i>Manual Full Tuning</i>	14
<i>Tuning Status / Error Indication</i>	15
Tuning Status Reports	16
Advanced Operation	17
<i>Manual Inductor/Capacitor Adjustments</i>	17
<i>High / Low Z Relay Adjustment</i>	17
<i>Manual Memory Store</i>	17
<i>Set Automatic Tuning SWR Threshold</i>	18
Command Summary	19
Application Information	19
<i>Mobile Operation</i>	19
<i>MARS/CAP Coverage</i>	19
Theory of Operation	19
The LDG Z-11Proll	21
A Word About Tuning Etiquette	23
Care and Maintenance	23
Technical Support	23
Two-Year Transferrable Warranty	23
Out Of Warranty Service	24
Returning Your Product For Service	24
Product Feedback	24

---

## INTRODUCTION

LDG pioneered the automatic, wide-range switched-L tuner in 1995. From its laboratories in St. Leonard, Maryland, LDG continues to define the state of the art in this field with innovative automatic tuners and related products for every amateur need.

Congratulations on selecting the Z-11ProII 100-watt automatic tuner. The Z-11ProII provides semi-automatic antenna tuning across the entire HF spectrum plus 6 meters, at power levels up to 125 watts. It will tune dipoles, verticals, Yagis, or virtually any coax-fed antenna. It will match an amazing range of antennas and impedances, far greater than some other tuners you may have considered, including the built-in tuners on many radios.

The Z-11ProII is similar to previous LDG tuners, but is specially designed with battery-powered operation in mind. It uses little power while tuning, and essentially zero power when in standby. Onboard solder pads allow easy connection of a user-supplied internal battery pack, for the ultimate in convenience and portability. The new Z-11ProII uses a lower battery voltage than previous versions of the Z-11Pro; this means fewer battery cells are required, making the Z-11ProII even more lightweight than its predecessors.

## JUMPSTART, OR “REAL HAMS DON’T READ MANUALS!”

Ok, but at least read this one section before operating the Z-11ProII:

Connect the HF/50 MHz antenna jack on the transceiver to the “TX” jack on the Z-11ProII, using a 50 ohm coax cable jumper.

Connect the 50 ohm coax antenna feedline to the “ANT” jack on the Z-11ProII.

Connect the Z-11ProII to a source of 7 to 16 volts DC @ 250mA, using the 2.5x5.5mm power jack on the rear of the Z-11ProII (center positive).

Select the desired operating frequency and mode.

Begin transmitting, in any mode.<sup>1</sup>

Wait for the tuning cycle to end; you’re now ready to operate!

---

<sup>1</sup> If transmitting in SSB mode, simply speak into the microphone. Tuning can occur while transmitting up to 125 watts, if the attached transceiver employs a “roll-back circuit” to protect it from high SWR. If the transceiver does not have a roll-back circuit, power should be limited to 25 watts when tuning, in order to avoid damage to the radio or tuner.

---

## SPECIFICATIONS

- .1 to 125 watts SSB and CW peak power, 30 watts on PSK and digital modes, and 100 watts on 6 meters.
- Latching relays for ultra-low power operation.
- 2,000 memories for instantaneous frequency and band changing.
- Built-in frequency counter for memory operation.
- Easy to read LEDs indicate SWR and operating status.
- 1.8 to 54.0 MHz coverage.
- Tunes 6 to 1000 ohm loads (16 to 150 on 6M), 6 to 4000 ohms with optional 4:1 Balun.
- For Dipoles, Verticals, Vees, Beams or any Coax Fed Antenna.
- DC power cable included.
- Optional external Baluns allows tuning of random length, long wire or ladder line fed antennas. Optional radio interface cables available. See web site for details.
- Power Requirements: 7 to 16 volts DC at 250mA max during tuning. 25  $\mu$ A idle current.
- Dimensions: 8.25”L x 5.0”W x 1.5”H.
- Weight: 1 pound 6 ounces (without internal batteries).

## AN IMPORTANT WORD ABOUT POWER LEVELS

The Z-11ProII is rated at 125 watts maximum power input *at most*. Many ham transmitters and transceivers, and virtually all amplifiers, output well over 125 watts. Power levels that significantly exceed specifications will definitely damage or destroy your Z-11ProII. If your tuner fails during overload, it could also damage your transmitter or transceiver. Be sure to observe the specified power limitations.

### IMPORTANT SAFETY WARNING

**Never install antennas or transmission lines over or near power lines. You can be seriously injured or killed if any part of the antenna, support or transmission line touches a power line. Always follow this antenna safety rule: the distance to the nearest power line should be at least twice the length of the longest antenna, transmission line or support dimension.**

---

## GETTING TO KNOW YOUR Z-11PROII

Your Z-11ProII is a quality, precision instrument that will give you many years of outstanding service; take a few minutes to get to know it.

The Z-11ProII may be used with any coax-connected HF transceiver or transmitter with up to 125 watts peak output power. The Z-11 Pro II can be set to tune automatically whenever the SWR exceeds a user-settable value, or it can be set to tune only by pressing the **Tune** button.

There is no power button on the Z-11ProII. The Z-11ProII automatically powers up at the start of a tuning cycle, and goes into an ultra-low-power sleep mode when tuning is complete. The latching relays hold the tuned configuration indefinitely, even when DC power is completely removed. Tuning memories are stored in FLASH memory.

The Z-11ProII has 2,000 frequency memories. When tuning on or near a previously tuned frequency, the Z-11ProII uses “Memory Tune” to recall the previous tuning parameters in a fraction of a second. If no memorized settings are available, the tuner runs a full tuning cycle, storing the parameters for memory recall on subsequent tuning cycles on that frequency. In this manner, the Z-11ProII “learns” as it is used, adapting to the bands and frequencies as it goes.

### Front Panel

On the front panel there are six pushbuttons and four LED indicator lights.

**Func:** Pressing momentarily selects secondary functions for other buttons.

**C Up / C Dn:** Manually increase/decrease capacitance.

**L Up / L Dn:** Manually increase/decrease inductance.

**Tune:** Initiates a tuning cycle, or places the tuner in bypass mode.

**1.5, 2.0, and >3.0 LEDs:** Indicate SWR.

**Tune LED:** Indicates tuning is in progress.

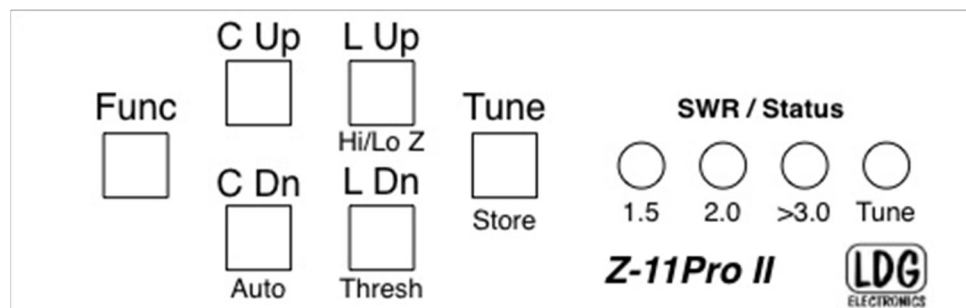

---

## Rear Panel

The rear panel of the Z-11ProII features five connectors.

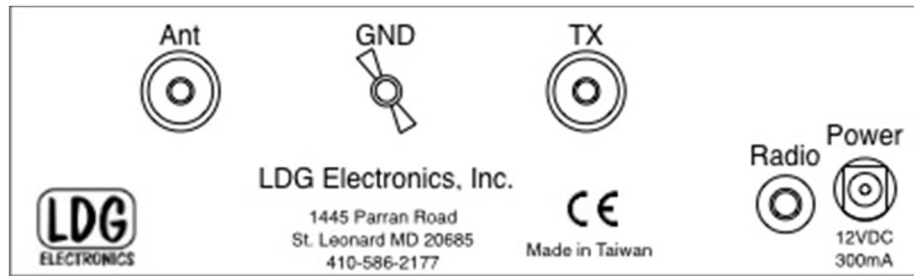

**ANT connector:** Connect the 50-ohm coax antenna feedline to this standard SO-239 connector.

**GND connector** (wing nut): Connect to antenna system ground.

**TX connector:** Connect a 50-ohm coax jumper cable from this standard SO-239 connector to the ANT jack on the back of the transceiver.

**RADIO connector:** Connect the optional radio interface cable to a compatible transceiver.

**Power connector** (coax DC jack): Connect the supplied DC power cable to a source of DC power, 7 to 16 volts DC, 300 mA. Center pin is positive.

---

## INSTALLATION

The Z-11ProII tuner is designed for indoor operation only; it is not water resistant. If you use it outdoors (Field Day, for example), you must protect it from the rain. The Z-11ProII is designed for use with coax-fed antennas. If use with longwires or ladder-line-fed antennas is desired, an external balun is required. The LDG RBA-4:1 or RBA-1:1 is ideal, depending on the antenna and transmission line used.

Place the Z-11ProII in a convenient location near the transceiver. Always turn your radio off before plugging or unplugging anything. The radio may be damaged if cables are connected or disconnected while the power is on.

Connect the HF antenna jack on the transceiver to the **TX** jack on the back of the Z-11ProII, using a 50 ohm coax cable rated 125 watts or higher.

Connect a 50-ohm antenna feedline coax to the **ANT** jack on the back of the Z-11ProII.

The Z-11ProII is designed to interface directly with many popular ICOM and Yaesu transceivers, enabling one button tuning. In the case of ICOM radios, the optional interface cable also powers the tuner.

For ICOM radios supporting the AH-3 or AH-4 external tuner, connect the 4-pin Molex connector of the optional ICOM interface cable to the radio's Tuner port. Then connect the 1/8" stereo plug on the other end of the ICOM interface cable to the jack marked **Radio** on the rear of the Z-11ProII. Connect the coaxial DC power plug of the ICOM interface cable to the **12 VDC Power** jack.

For Yaesu FT-857 and FT-897, use the optional Y-ACC cable and plug the red end marked **Radio** into the transceiver's **ACC** port. Plug the black end of the Y-ACC cable into the jack marked **Radio** on the rear of the Z-11ProII.

Unless the Z-11ProII is being powered by the ICOM radio interface cable as above, you'll also need to plug in the supplied DC coaxial power cable<sup>2</sup>. This cable has a 2.5x5.5mm coaxial plug on the end. Plug the coaxial plug into the **12 VDC Power** jack on the rear of the Z-11ProII, and connect the other end to a DC power source between 11 and 16 volts DC, capable of supplying up to 300 mA. The red wire is positive.

Grounding the Z-11ProII tuner will enhance its performance and safety. LDG recommends that you connect your tuner to a suitable ground. A common ground rod connected to buried radials is ideal, but a single ground rod, a cold water pipe, or the screw that holds the cover on an AC outlet can provide a serviceable ground. LDG strongly recommends the use of a properly installed, high quality lightning arrestor on all antenna cables.

---

<sup>2</sup> Or, the Z-11ProII may be powered by optional internal batteries. See the section on Battery Installation for more details.

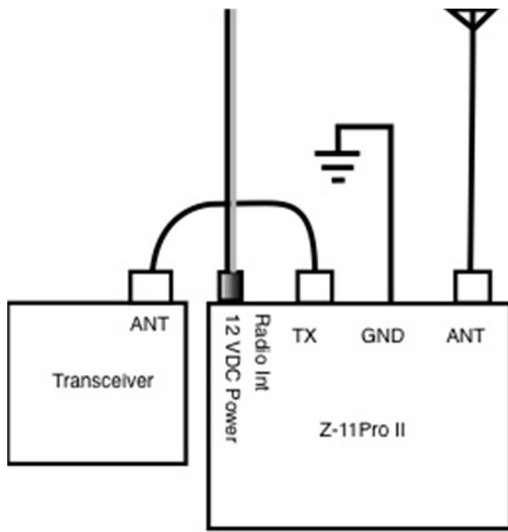

Typical Installation

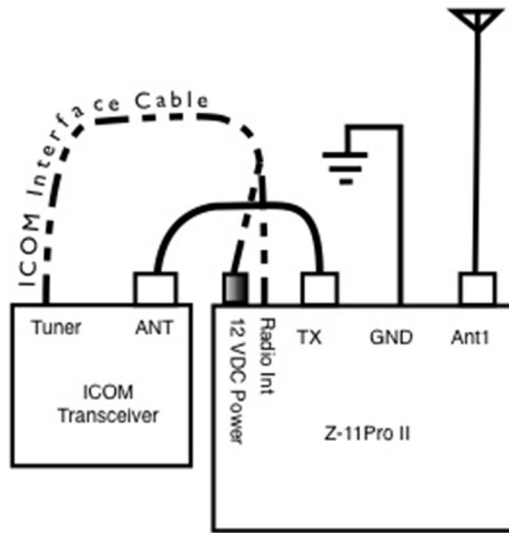

ICOM Installation

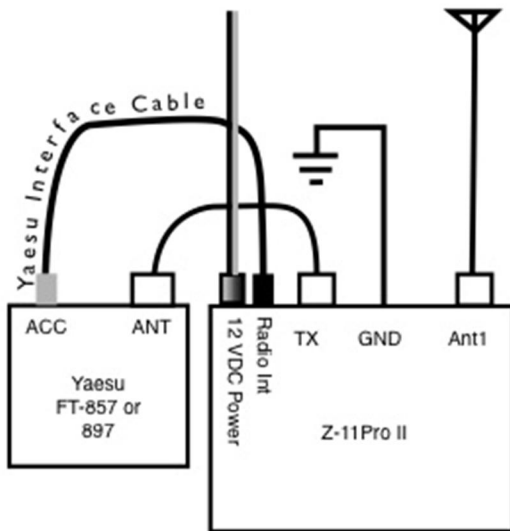

FT-857/897 Installation



---

## OPTIONAL INTERNAL BATTERY INSTALLATION

The Z-11ProII uses so little power that it is practical to install an internal battery pack, making it more convenient to use for portable operation. The Z-11ProII has solder pads marked **B+** and **B-** near the power jack on the internal circuit board. These solder pads are provided to allow easy installation of an internal battery pack.

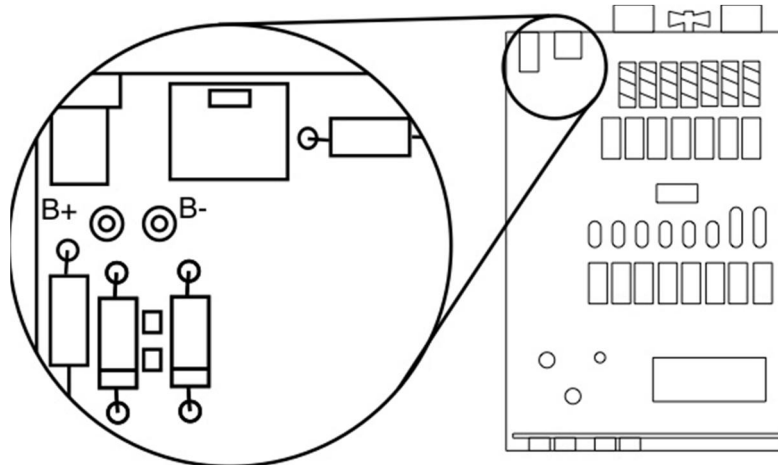

The Z-11ProII will operate on any input voltage from 7 to 16 volts DC, which opens up a wide range of internal battery possibilities. The most common would be 6 or 8 AA or AAA batteries in a battery holder, with the holder double-sided-taped to the top of the relay bank. A single 9V alkaline battery will work, as well, though it will need to be changed more frequently, as 9V batteries typically have low (~300 mAh) capacity compared to AAA or AA batteries.

Appropriate battery holders are available from Radio Shack ([www.radioshack.com](http://www.radioshack.com)), Digi-Key ([www.digikey.com](http://www.digikey.com)), or Mouser ([www.mouser.com](http://www.mouser.com)).

To install a battery holder inside the Z-11ProII, remove the four screws that secure the cover, and remove the cover from the unit. Locate the two solder pads marked **B+** and **B-** near the DC power jack. Solder the positive lead (normally red) of the battery pack to the **B+** pad, and solder the negative lead (normally black) to the **B-** pad. Be careful not to create any solder bridges or shorts.

Secure the battery pack either to the underside of the lid, or to the top of the bank of relays, using double-sided foam tape. Install batteries, and, if necessary, place tape over the batteries to keep them secured in the holder. Replace the Z-11ProII cover, being careful not to pinch the battery wires.

---

Although the Z-11ProII may be operated on external DC power even while batteries are installed, note that the Z-11ProII will not charge the internal batteries. If rechargeable batteries are used, they must be removed from the Z-11ProII and recharged in an external charger.

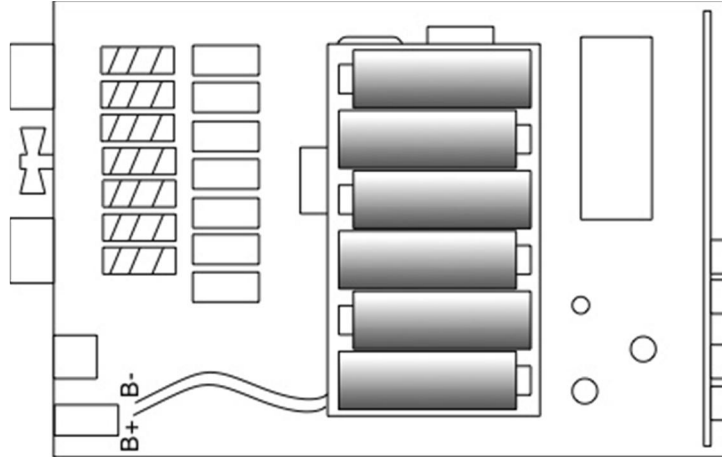

Battery life will vary depending upon usage and the type of battery selected, but in most cases, the batteries will last at least one year before requiring replacement.

Remove batteries from the Z-11ProII when the unit will not be used for an extended period of time, to prevent possible damage due to battery leakage.

## OPERATION

### *Basic Operation*

The Z-11ProII is operated from the six front panel buttons. Each button has one or more associated functions. The front panel labeling shows the primary and secondary function of each button. Primary functions are accessed by pressing the associated button momentarily, or pressing and holding the button. Secondary functions are accessed by first pressing and releasing the **FUNC** button momentarily, and then pressing the associated button. If the **FUNC** button is pressed accidentally, its action may be cancelled by pressing it a second time, or simply waiting a few seconds for it to “time out”.

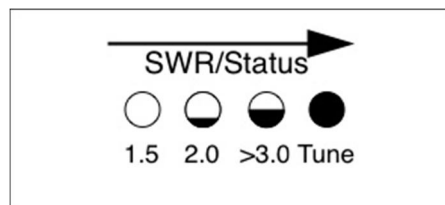

Func On

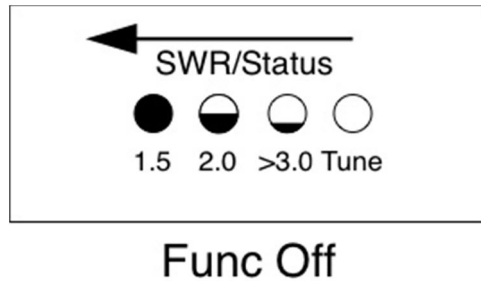

The **FUNC** mode is indicated on the front panel LEDs by the LEDs quickly scrolling to the right. When **FUNC** mode is cancelled, the LEDs scroll quickly to the left.

### *Basic Tuning*

The Z-11ProII automates the process of matching an antenna load to the 50-ohm characteristic impedance of coaxial cable feedline. Tuning occurs in one of two modes: Automatic tuning mode, and Semiautomatic tuning mode.

When in **Automatic tuning mode**, the Z-11ProII will begin a tuning cycle any time that there is forward RF power, and the measured SWR exceeds a preset threshold.

In **Semiautomatic tuning mode**, a tuning cycle will only begin when specifically requested by pushing the **TUNE** button on the front of the tuner, or by pushing the **TUNER/CALL** button on an appropriately interfaced compatible transceiver.

In either Automatic or Semiautomatic modes, the Z-11ProII employs two different types of tuning cycles: a memory tuning cycle and a full tuning cycle. The **Tune** LED lights during tuning.

The **memory tuning cycle** attempts to tune quickly, based on having previously tuned on the present frequency selection. If the tuner previously was successful in tuning on the currently selected frequency, the settings for that match will be loaded into the tuner relays, and checked to see that an acceptable SWR match is found. If memory tuning fails to find a match, the tuner falls through to a full tuning cycle.

A **full tuning cycle** “starts from scratch” and begins a fixed tuning sequence where the Z-11ProII rapidly tries varying combinations of inductance and capacitance values, and then zeroes-in on the best match possible. When the tuning cycle is complete, if an acceptable match was found, the inductance and capacitance settings are saved in a memory associated with the selected frequency, so that they may be recalled quickly in the future via a memory tuning cycle.

In this manner, the Z-11ProII “learns”; the longer you use it, the more closely it adapts itself to the bands and frequencies used. Most users will probably use memory tuning most of the time; it takes advantage of any saved tuning settings, but automatically defaults to a full tuning cycle if no stored data is available.

In both cases, at the end of the tuning cycle, the carrier is held for 1.5 seconds after tuning is complete, so that the final SWR may be read on the transceiver’s internal SWR meter or another inline SWR meter, and the front panel LED will indicate the status of the tuning cycle.

---

The tuner may also be placed in “bypass” mode where it is electrically removed from the antenna system.

*Toggle Bypass Mode*

To toggle between bypassed and active mode, press the front panel **TUNE** button on the Z-11ProII momentarily. All four LEDs will flash three times to indicate that the tuner is in bypass mode. Press the front panel Tune button momentarily again to recall the previous tuner settings. The LEDs will flash once to indicate that the tuner is no longer bypassed. This function may be useful if you wish to compare antenna performance with and without the benefit of the tuner’s matching network.

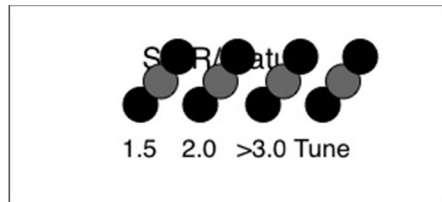

3 Blinks = Bypass

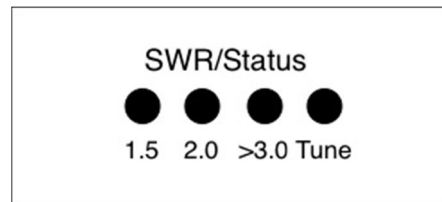

1 Blink = Active

---

## Toggle Automatic / Semiautomatic Tuning Mode

As described above, the Z-11ProII employs a fully automatic and a semi-automatic tuning mode. To toggle between the two, press and release the **FUNC** button, and then press the **C DN/AUTO** button. When **Automatic tuning mode** is selected, the inner two LEDs will blink. Press **FUNC** and then **C DN/AUTO** again, and the outer two LEDs will blink, indicating **Semiautomatic tuning mode**.

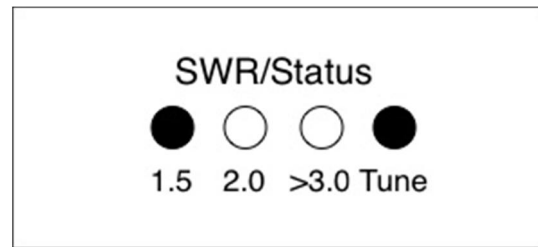

### Semiautomatic Tuning Mode

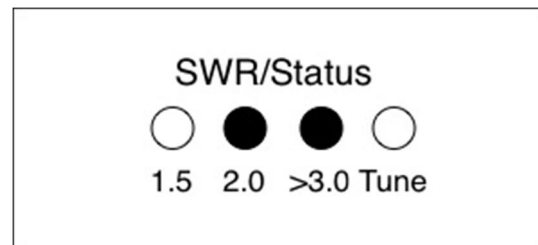

### Automatic Tuning Mode

#### *Automatic Tuning Mode*

When in Automatic Tuning Mode, simply key the radio in any transmit mode, and the Z-11 Pro II will begin tuning any time that the SWR exceeds a preset threshold. The **Tune** LED lights during tuning, and the SWR LEDs indicate the SWR during the tuning process.

Continue transmitting (on AM or SSB, keep talking) until the tuning cycle is complete. A memory tune is attempted first. If the memory tune does not find a previously stored match, a full tuning cycle is initiated. When the tuning cycle is complete, the status of the tune will be displayed on the LEDs, and then the final SWR will be displayed. See the section on *Status Indication* for the possible tuning status indications.

#### *Manual Memory Tuning*

In addition to Automatic Tuning Mode, there are two semi-automatic tuning modes, **memory tuning mode** and **full tuning mode**. Either can be requested at any time, including even when the Z-11ProII is set for fully automatic tuning.

---

To manually initiate a memory tuning cycle, press and hold the **TUNE** button for 0.5 to 2.5 seconds, and then release. The outer two front panel LEDs will light up to indicate that a memory tuning cycle is requested.

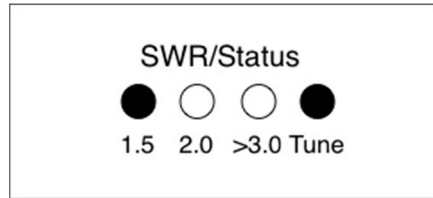

### Memory Tune Requested

If you are using the ICOM or Yaesu radio interface cable, the radio will automatically reduce power, switch to CW mode, and transmit for as long as is required to complete the tuning cycle, and then will return to the previous operating mode and power level when completed.

If you are not using the ICOM or Yaesu radio interface cable, you will need to key the radio manually. In SSB or AM mode, begin talking into the microphone. Hold down the code key on CW. Note that if your radio does not incorporate an SWR rollback circuit<sup>3</sup>, you will first need to reduce power to 25 watts or less. In no case should you transmit more than 125 watts.

If the memory tune is not successful, the Z-11ProII falls through to full tuning cycle. At the end of a tuning cycle, the LEDs cycle inwards to indicate a successful tune.

If using the Z-11ProII with an ICOM transceiver connected with the optional ICOM interface cable, pressing the TUNER/CALL button on the transceiver will also initiate a memory tuning cycle.

#### *Manual Full Tuning*

As with the memory tuning cycle, if your radio is not equipped with a rollback circuit, reduce power to 25 watts or less before tuning. To manually initiate a full tuning cycle, press and hold the **TUNE** button for more than 2.5 seconds and then release. The outer two front panel LEDs will light up, then the inner two LEDs will light, to indicate that a full tuning cycle is requested.

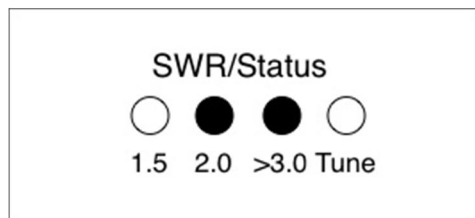

### Full Tune Requested

---

<sup>3</sup> An SWR rollback circuit automatically reduces the output power level when high SWR is present. Check your radio's manual to see if your radio uses a rollback circuit.

If you are using one of the optional radio interface cables, the radio will automatically reduce power, switch to CW mode, and begin transmitting while the full tuning cycle is in progress. If not, key the radio (Talk into the mic on SSB or AM, close the key on CW) until the tuning cycle is complete. Note that the SWR LEDs display the intermediate SWR results during tuning, and will display the final SWR once tuning is complete.

*Tuning Status / Error Indication*

During normal operation, the front panel LEDs on the Z-11ProII are extinguished during receive, and will light up to indicate the current SWR reading upon transmit. SWR levels may be decoded as follows:

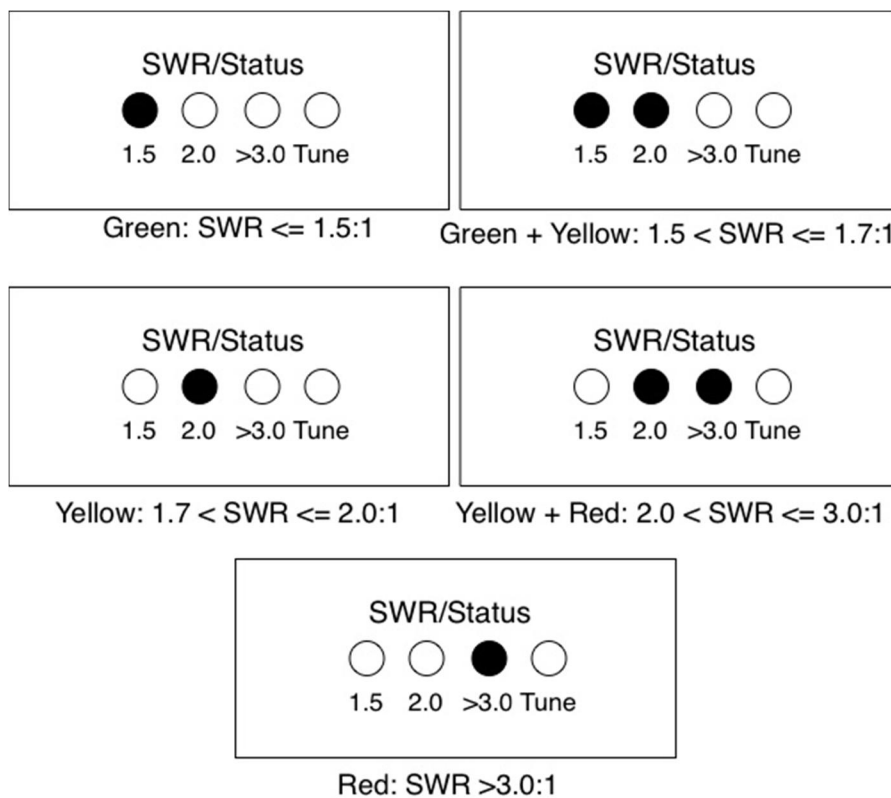

During or after tuning, the LEDs can indicate error conditions as well. Upon successful completion of a tuning cycle, the outer two LEDs will light, then the inner two. Other error conditions are explained in the table "Tuning Status Reports."

## Tuning Status Reports

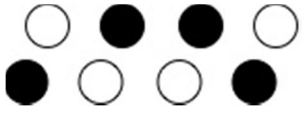
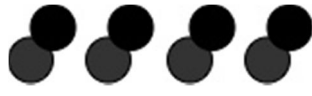
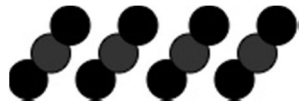
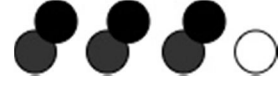
<i>Condition</i>	<i>Report</i>
Successful tune	Outer LEDs light, then inner LEDs. 
RF Lost during tune	All LEDs blink twice. 
No RF found	All LEDs blink three times. 
No match found	Leftmost three LEDs blink twice. 



---

## ADVANCED OPERATION

### *Manual Inductor/Capacitor Adjustments*

In some rare cases, after tuning, it may be desirable to adjust the inductance and capacitance settings that the Z-11ProII came up with during the tuning process. This is more likely to occur when attempting to tune an antenna far from its resonant frequency.

The **C Up**, **C Dn**, **L Up**, and **L Dn** buttons may be used to increment or decrement the amount of capacitance or inductance, respectively. A momentary press of any of these buttons increments or decrements the value by one unit. Repeatedly press one of these buttons to increment or decrement multiple times, or simply hold the button and the button will auto-repeat. You may also transmit while incrementing or decrementing, so that the SWR value is displayed.

### *High / Low Z Relay Adjustment*

In addition to being able to manually control the inductor and capacitor value of the Z-11ProII, it is also possible to manually set the high/low impedance relay, which determines whether the tuner is an L-C configuration or a C-L configuration. To toggle the state of the high/low impedance relay, press **FUNC**, then **L Up (Hi/Lo Z)**. The LED display will indicate one of two patterns to confirm the setting.

### *Manual Memory Store*

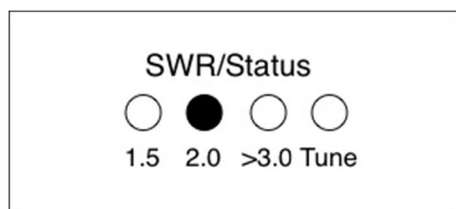

Low Impedance

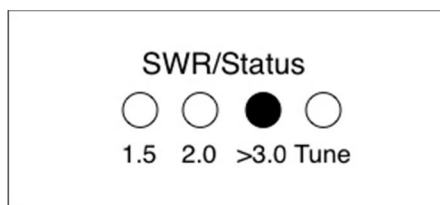

High Impedance

Once manual adjustments are complete, press **FUNC** and then **TUNE (Store)** momentarily, to store the current relay settings in the memory associated with the frequency last transmitted upon.

---

### Set Automatic Tuning SWR Threshold

When the Z-11ProII is in fully automatic tuning mode, it begins tuning any time RF is present, and the SWR exceeds a preset threshold. That threshold may be programmed to any desired value between 1.5:1 and 3.0: To set the SWR threshold, press **FUNC** then **L Dn / Thresh**. The LEDs will show the current setting of the SWR threshold. Press **FUNC** then **L Dn / Thresh** again to advance through the possible settings.

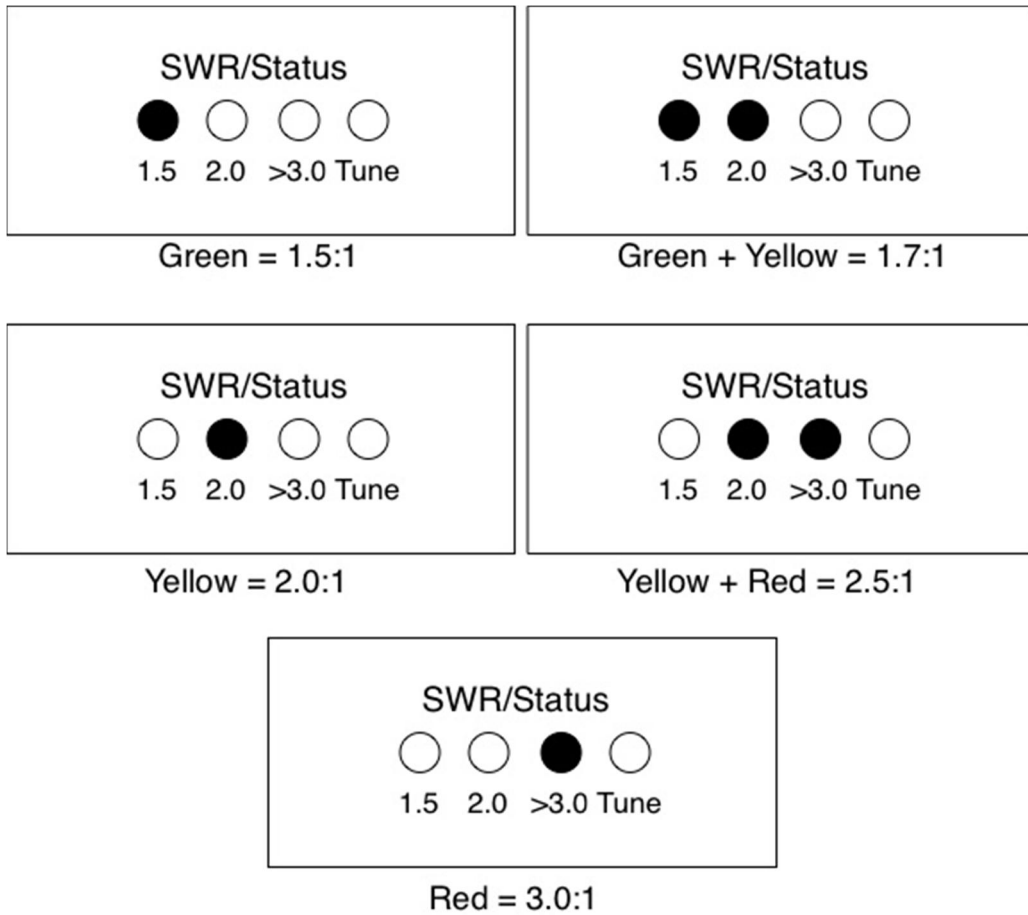

## COMMAND SUMMARY

<i>Function</i>	<i>Button Sequence</i>
Toggle Auto / Semi mode	<b>FUNC</b> then <b>C Dn</b>
Auto Tune Threshold	<b>FUNC</b> then <b>L Dn</b>
High / Low Z Select	<b>FUNC</b> then <b>L Up</b>
Full Tuning Cycle	Hold <b>TUNE</b> for >2.5 seconds
Memory Tuning Cycle	Hold <b>TUNE</b> for 0.5 to 2.5 seconds
Toggle Bypass Mode	Press <b>TUNE</b> momentarily

## APPLICATION INFORMATION

### *Mobile Operation*

The Z-11ProII is perfectly suited to mobile operation. It can be installed under the dashboard along with the transceiver, or mounted remotely. The only requirement is that the tuner remains dry.

If it is desired that the Z-11ProII is positioned farther from the transceiver than the optional cable length allows, a custom cable will need to be constructed. This can be accomplished in two ways: Cut the optional cable and solder a jumper wire between all the connections, or purchase new connectors and cable to construct a custom-length interface cable from scratch.

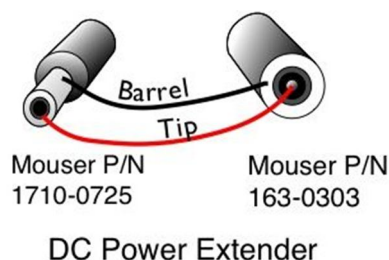
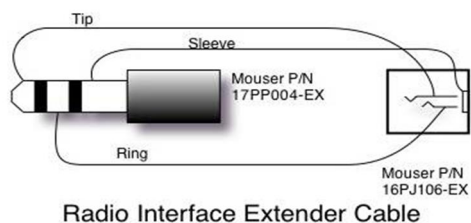

### *MARS/CAP Coverage*

The Z-11ProII provides continuous tuning coverage over its specified range; not just in the ham bands. This makes it useful for MARS or CAP operation, or any other legal HF operation.

---

## THEORY OF OPERATION

### *Some basic ideas about impedance*

The theory underlying antennas and transmission lines is fairly complex, and in fact employs a mathematical notation called “complex numbers” that have “real” and “imaginary” parts. It is beyond the scope of this manual to present a tutorial on this subject<sup>4</sup>, but a little background will help in understanding what the Z-11ProII is doing, and how it does it.

In simple DC circuits, the wire resists current flow, converting some of it into heat. The relationship between voltage, current, and resistance is described by the elegant and well-known “Ohm’s Law”, named for Georg Simon Ohm of Germany, who first discovered the principle in 1826. In RF circuits, an analogous but more complicated relationship exists.

RF circuits also resist the flow of electricity. However, the presence of capacitive and inductive elements causes the voltage to lead or lag the current, respectively. In RF circuits, this resistance to the flow of electricity is called “impedance”, and can include all three elements: resistive, capacitive, and inductive.

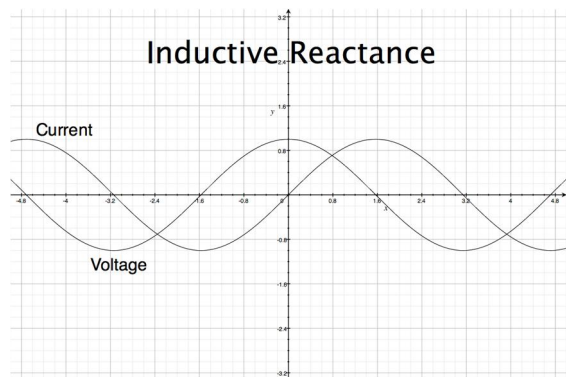
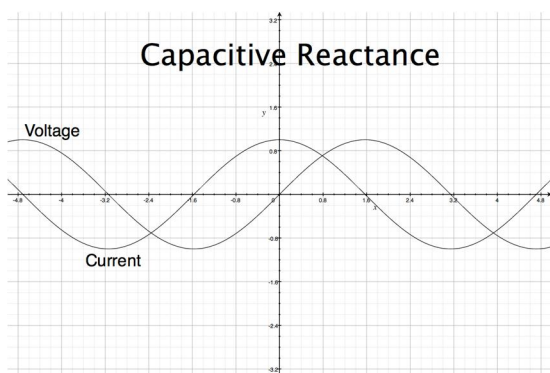

The output circuit of a transmitter consists of inductors and capacitors, usually in a series/parallel configuration called a “pi network”. The transmission line can be thought of as a long string of capacitors and inductors in series/parallel, and the antenna is a kind of resonant circuit. At any given RF frequency, each of these can exhibit resistance, and impedance in the form of capacitive or inductive “reactance”.

### *Transmitters, transmission lines, antennas, and impedance*

The output circuit of a transmitter, the transmission line, and the antenna all have a characteristic impedance. For reasons beyond the scope of this document, the standard impedance is nominally 50 ohms resistive, with zero capacitive and zero inductive components. When all three parts of the system have the same impedance, the system is said to be “matched”, and maximum transfer of power from the transmitter to the antenna occurs. While the transmitter output circuit and transmission line are of fixed, carefully designed impedance, the antenna presents 50-ohm, non-reactive load only at its natural resonant frequencies. At other frequencies,

---

<sup>4</sup> For a very complete treatment of this subject, see any edition of the ARRL Handbook for Radio Communications (previously the Handbook For Radio Amateurs).

---

it will exhibit capacitive or inductive reactance, causing it to have an impedance other than 50 ohms.

When the impedance of the antenna is different from that of the transmitter and transmission line, a “mismatch” is said to exist. In this case, some of the RF energy from the transmitter is reflected from the antenna back down the transmission line and into the transmitter. If this reflected energy is strong enough, it can damage the transmitter’s output circuits.

The ratio of transmitted to reflected energy is called the “standing wave ratio”, or SWR. An SWR of 1 (sometimes written 1:1) indicates a perfect match. As more energy is reflected, the SWR increases to 2, 3, or higher. As a general rule, modern solid state transmitters must operate with an SWR of 2 or less. Tube excitors are somewhat more tolerant of high SWR. If a 50 ohm antenna is resonant at the operating frequency, it will show an SWR close to 1. However, this is usually not the case; operators often need to transmit at frequencies other than resonance, resulting in a reactive antenna and a higher SWR.

$$SWR = \frac{1 + \sqrt{R/F}}{1 - \sqrt{R/F}} \quad \text{where F = Forward power (watts), R = Reflected power (watts)}$$

SWR is measured using a device called an “SWR bridge”, inserted in the transmission line between the transmitter and the antenna. This circuit measures forward and reflected power from which SWR may be calculated (some meters calculate SWR for you). More advanced units can measure forward and reflected power simultaneously, and show these values and SWR at the same time.

An antenna tuner is a device used to cancel out the effects of antenna reactance. Tuners add capacitance to cancel out inductive reactance in the antenna, and vice versa. Simple tuners use variable capacitors and inductors; the operator adjusts them by hand while observing reflected power on the SWR meter until a minimum SWR is reached. The LDG Electronics Z-11ProII automates this process.

No tuner will fix a bad antenna. If the antenna is far from resonance, the inefficiencies inherent in such operation are inescapable; it’s simple physics. Much of the transmitted power may be dissipated in the tuner as heat, never reaching the antenna at all. A tuner simply “fools” the transmitter into behaving as though the antenna was resonant, avoiding any damage that might otherwise be caused by high reflected power. For best performance, the antenna used should always be as close to resonance as is practical.

## **THE LDG Z-11PROII**

In 1995, LDG Electronics pioneered a new type of automatic antenna tuner. The LDG design uses banks of fixed capacitors and inductors, switched in and out of the circuit by relays under microprocessor control. An additional relay switches between high and low impedance ranges. A built-in SWR sensor provides feedback; the microprocessor searches the capacitor and inductor banks, seeking the lowest possible SWR. The tuner is a “Switched L” network, consisting of series inductors and parallel capacitors. LDG chose the L network for its minimum number of

parts and its ability to tune unbalanced loads, such as coax-fed dipoles, verticals, Yagis, and, in fact, virtually any coax-fed antenna.

The series inductors are switched in and out of the circuit, and the parallel capacitors are switched to ground under microprocessor control. The high/low impedance relay switches the capacitor bank either to the transmitter side of the inductor bank, or to the antenna side. This allows the Z-11ProII to handle loads that are either greater than or less than 50 ohms. All relays are sized to carry 125 watts continuously.

The SWR sensor is a variation of the Bruene circuit. This SWR measuring technique is used in most dual-meter and direct-reading SWR meters. Slight modifications were made to the circuit to provide voltages instead of currents for the analog-to-digital converters that provide signals proportional to the forward and reflected power levels. The single-lead primary through the center of the sensor transformer provides RF current sampling. Diodes rectify the sample and provide a DC voltage proportional to RF power. These two voltages are read by the ADCs in the microprocessor, and are used to compute SWR in real time.

The relays are powered by the DC input or internal batteries. The relays are a latching type, and so they consume no current when not actively switching.

Although the microprocessor's oscillator runs at 32 MHz, which allows the main tuning routine to execute in only a few milliseconds, the relays require several milliseconds of settling time for every combination of inductors and capacitors. Thus, it may take several seconds before all relay combinations are exhausted, in the case of a difficult tune.

The tuning routine uses an algorithm to minimize the number of tuner adjustments. The routine first de-energizes the high/low impedance relay if necessary and then individually steps through the inductors to find a coarse match. With the best inductor selected, the tuner then steps through the individual capacitors to find the best coarse match. If no match is found, the routine repeats the coarse tuning with the high/low impedance relay energized. The routine then fine tunes the inductors and capacitors. The program checks LC combinations to see if a 1.5:1 or lower SWR can be obtained and stops when it finds a good match.

The microprocessor runs a fine tune routine just after the tuner finds a match of 1.5:1 or less. This fine tune routine now tries to reduce the SWR as low as possible (not just to 1.5); it takes about half a second to run.

REV	FWD Power (watts)								
	20	30	40	50	60	70	80	90	100
2	1.92	1.70	1.58	1.50	1.45	1.41	1.38	1.35	1.33
4	2.62	2.15	1.92	1.79	1.70	1.63	1.58	1.53	1.50
6	3.42	2.62	2.26	2.06	1.92	1.83	1.75	1.70	1.65
8	4.44	3.14	2.62	2.33	2.15	2.02	1.92	1.85	1.79
10	5.83	3.73	3.00	2.62	2.38	2.22	2.09	2.00	1.92
12	7.87	4.44	3.42	2.92	2.62	2.41	2.26	2.15	2.06
14	11.24	5.31	3.90	3.25	2.87	2.62	2.44	2.30	2.20
16	17.94	6.42	4.44	3.60	3.14	2.83	2.62	2.46	2.33
18	37.97	7.87	5.08	4.00	3.42	3.06	2.80	2.62	2.47
20		9.90	5.83	4.44	3.73	3.30	3.00	2.78	2.62
22		12.92	6.74	4.94	4.07	3.55	3.21	2.96	2.77
24		17.94	7.87	5.51	4.44	3.83	3.42	3.14	2.92
26		27.96	9.32	6.17	4.85	4.12	3.65	3.32	3.08
28		57.98	11.24	6.95	5.31	4.44	3.90	3.52	3.25
30			13.93	7.87	5.83	4.79	4.16	3.73	3.42
32			17.94	9.00	6.42	5.18	4.44	3.95	3.60
34			24.63	10.40	7.09	5.60	4.75	4.19	3.80
36			37.97	12.20	7.87	6.07	5.08	4.44	4.00
38			77.99	14.60	8.80	6.60	5.44	4.71	4.21
40				17.94	9.90	7.19	5.83	5.00	4.44
42				22.96	11.24	7.87	6.26	5.31	4.68
44				31.30	12.92	8.65	6.74	5.65	4.94
46				47.98	15.08	9.56	7.27	6.02	5.22
48				97.99	17.94	10.63	7.87	6.42	5.51
50					21.95	11.92	8.55	6.85	5.83



---

## **A WORD ABOUT TUNING ETIQUETTE**

Be sure to use a vacant frequency when tuning. With today's crowded ham bands, this is often difficult. However, causing interference to other hams should be avoided as much as possible. The Z-11ProII's very short tuning cycle, as little as a fraction of a second, minimizes the impact of tuning transmissions.

## **CARE AND MAINTENANCE**

The Z-11ProII tuner is essentially maintenance-free. Power limits in this manual should be strictly adhered to. The outer case may be cleaned as needed with a soft cloth slightly dampened with household cleaning solution. As with any modern electronic device, the Z-11ProII can be damaged by temperature extremes, water, impact, or static discharge. LDG strongly recommends the use of a good quality, properly installed lightning arrestor in the antenna lead.

## **TECHNICAL SUPPORT**

The LDG Customer Support Center staff is ready to answer your product question by telephone and over the Internet. We know that you will enjoy your product even more knowing LDG is ready to answer your questions as the need arises.

Our website links you to the on-line Customer Support Center where you can send us a question, do your own research in the LDG Product Knowledge Books, and read through lists of frequently asked product questions. LDG regularly updates on-line information so the best on-line support information is available all day and every day.

The LDG website provides links to product manuals, just in case you lose this one! When you are thinking about the purchase of other LDG products our website also has complete product specifications and photographs you can use to help make your purchase decision. Don't forget the links to all of the quality LDG Dealers also ready to help you make that purchase decision.

## **TWO-YEAR TRANSFERRABLE WARRANTY**

Your product is warranted against manufacturer defects in parts and labor for two full years from the date of purchase. This two-year warranty is also transferable. When you sell or give away your LDG product, give the new owner a copy of the original sales receipt and the two-year warranty goes with the new owner.

There is no need to complete a warranty card or to register an LDG product. Your product receipt establishes eligibility for warranty service so save that receipt. Send your receipt with the product whenever you send your product to LDG for repair. Products sent to LDG without a receipt are considered requests for out-of-warranty repair.

LDG does not warranty against product damage or abuse. This means that a product failure, as determined by LDG, to be caused by the customer or by other natural calamity (e.g. lightning) is not covered under the two-year warranty. Damage can be caused by failure to heed the product's published limitations and specifications or by not following good Amateur practice.

---

## **OUT OF WARRANTY SERVICE**

Any time a product fails after the warranty, LDG wants to help you get it fixed. Send the product to us for repair. We will determine what needs to be done, and based on your prior instruction, either contact you with an estimate or fix it and contact you with a request to pay any repair charges. Please contact LDG if you have any questions before you send us an out-of-warranty product for repair.

## **RETURNING YOUR PRODUCT FOR SERVICE**

Returning a product to LDG is easy. We do not require a return merchandise authorization, and there is no need to contact LDG to return your product. Visit the Customer Support Center and download the LDG Product Repair Form. On the Repair Form tell the LDG technicians exactly what happened or didn't happen and why you believe the product needs servicing. The technician attempts to duplicate the problem(s) you had based on how well you describe it so take the time to be accurate and complete.

Ask your shipper for a tracking number or a delivery verification receipt. This way you know the product arrived safely at LDG. Be sure to give us your email address so our shipper can alert you online when your product is en-route back to you. Please be assured that our staff makes every effort to complete repairs ahead of our published wait time. Your patience is appreciated.

Repairs can take six to eight weeks, but are usually faster. The most recent information on returning products for service is found at the LDG Customer Support Center. Send your carefully packaged unit with the Repair Form to:

LDG Electronics, Inc.  
Attn: Repair Department  
1445 Parran Rd  
St. Leonard, MD 20685

## **PRODUCT FEEDBACK**

We encourage product feedback! Tell us what you really think of your LDG product. In a card, letter, or email (preferred) tell us how you used the product and how well it worked in your application. Send along a photo or even a schematic or drawing to illustrate your narrative. We like to share your comments with our staff, our dealers, and even other customers at the LDG website.

<http://www.ldgelectronics.com/>

